

MEERA

RING TWISTER

Ring Doubling and
Twisting Machines



INNOVATIVE AUTHENTIC FUTURISTIC

RING TWISTER

Ring Doubling and
Twisting machine

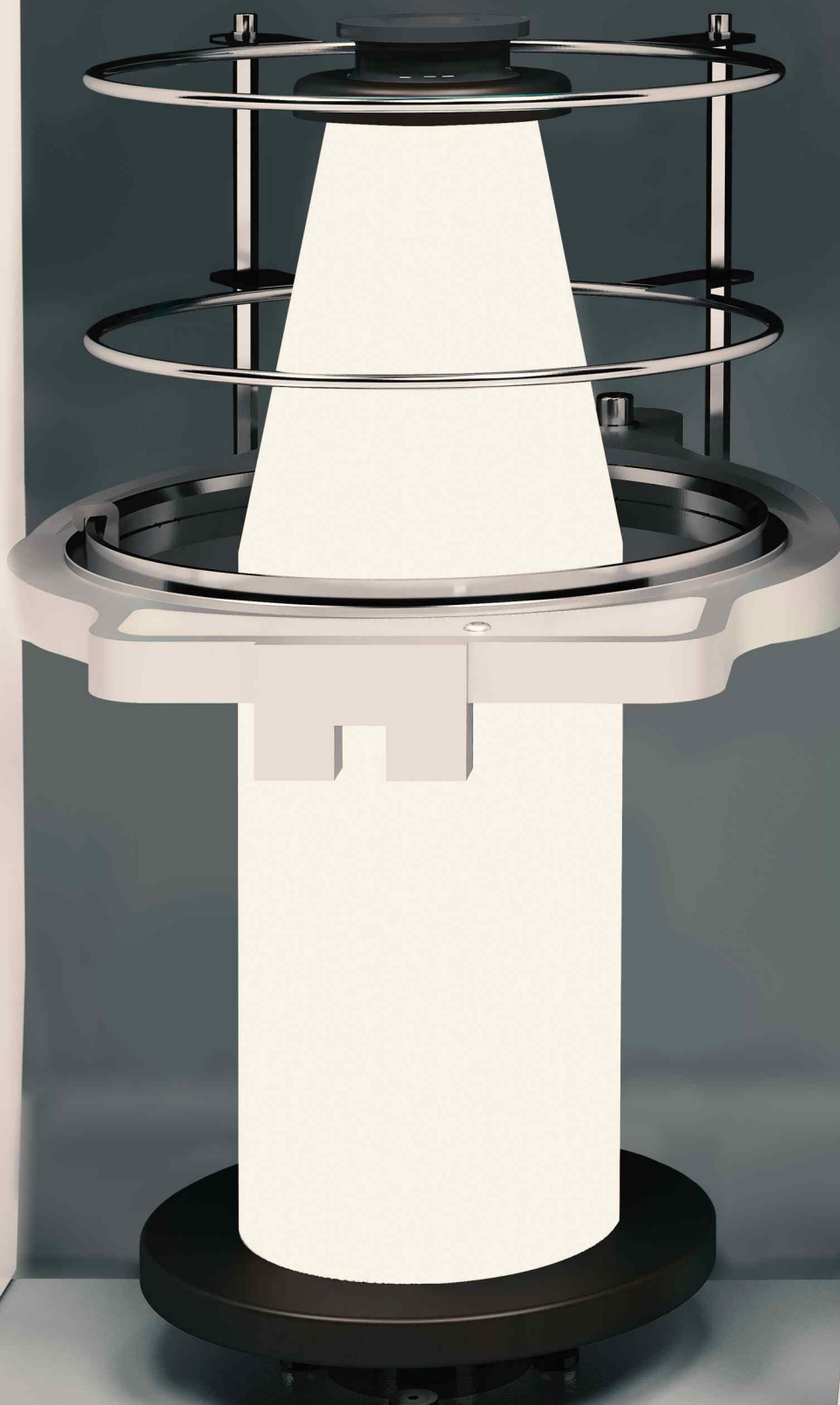

RING TWISTER

Meera has been the leading manufacturer of Heavy Duty Ring Twister machines for many years. Our Ring Doubler / Twister has been used by manufacturer of Raffia, Ropes, Cords, Glass Yarns in India and abroad for premium quality Products. There are several advantages that makes Meera heavy duty Ring Twister at par with International Standards.

ADVANTAGES

- Delivery Speed up to 120 meters / min.
- Spindle Speed upto 8000 rpm.
- Precise Ring Rail Control.
- Pneumatic Pressurized Yarn Feeding.
- Individual Spindle Motor System.
- Tested Sections with Modular packing reduce setup times.
- Panel For Setting and Displaying Spindle Speed, Twist Level, Crossing Angle, Stroke Length, Winding Type Yarn Speed Etc.
- Outstanding Cost Performance ratio.

Highlights

Technology	Ring Twisting
Suitable Yarn	PES, PP, PE, HDPE, PA Fibrillated, Cotton, Wool, Acrylics,
Application	Fiberglass, Rayon, Packaging Yarns, Artificial Grass, Ropes, Mops and Floor , Carpets, Protection, Cords, Braider Yarns
Denier Range	600 - 120000 , 0.05Nm
Construction	600/2, 1000/4, 2000/6
Speed	UPTO-8000 RPM
Voltage	220/380/440 50-60 Hz
Drive System	Fully Inverter Controlled Drive For Spindle and Take Up
Model	R-140, R-160, R-200, R-250, R-300
Bobbin Shape:	Bobbin, Bottle, Double Flanged Bobbin
Certification	ISO 9001 and CE MARK

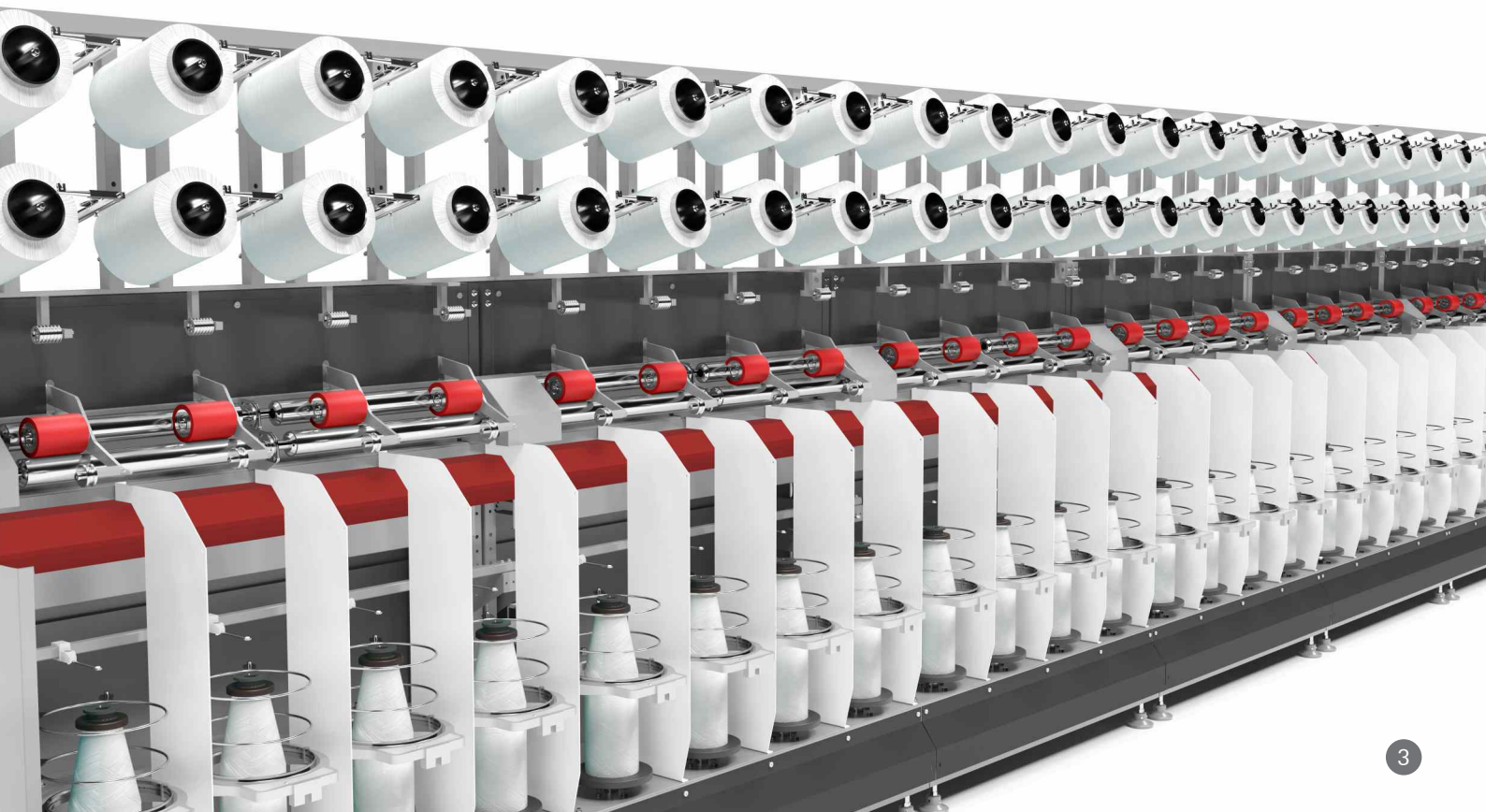



FEATURES

MEERA Ring Twister is an innovative high performance ring twisting machine for Single Step Plying / Doubling Twisting machine.

Our twisting systems provide an optimum level of variability and flexibility for all type of Spun Yarn, Filament Yarn for Various normal and Technical Textile applications.

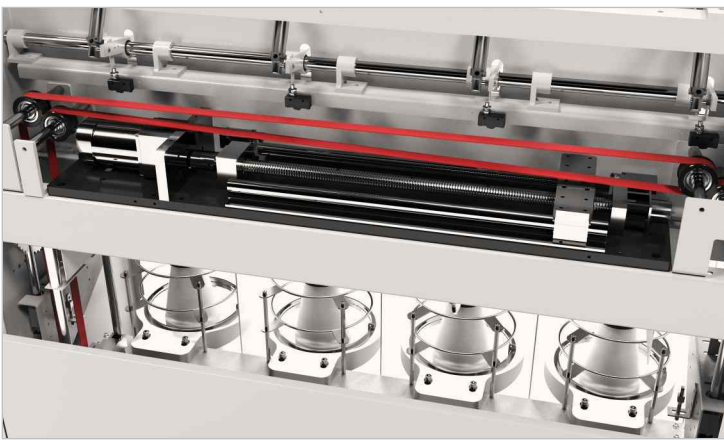

PRECISE RAIL RING CONTROL

- Monitoring by linear encoder
- Weight compensation by counterweights
- Precise yarn storage and variable package building
- Perfect unwinding from the twisted package for efficient Post processes.



RUBBERISED PRESSURE ROLLER WITH HYDRAULIC PISTON

- Rubberised Pressure Roller With Pneumatic Piston For Auto Lifting
- It creates a smooth yarn path even for highly sensitive yarns like Glass, carbon and others.
- In the event of yarn breakage, a sensing device sense the breakage results in Spindle stop and auto lifting of pressure roller.



EASY TO OPERATE BUTTONS / PANEL

- Start button
- Stop button
- EMERGENCY STOP mushroom button
- S/Z key switch for twist direction.

Touch Panel For Easy to Adjust Parameters Like amount of twist, Spindle, speed, crossing angle Length and time-based shut-down, Individual Length Counter (Optional) etc.

The production parameters entered can be stored in an article library and called up whenever required. Advance Reporting available like, Delivery speed, operating hours, Spindle Wise Breakage report, Production, Operator Eciency etc. The computer is equipped with a USB connection (Optional)



MOTORISED SPINDLE

- Ring twisting spindle.
- Speed range 3000 rpm up to 8000 rpm.
- Spindle motors with system control and thermal protection.
- Electro Magnetic / Pneumatic spindle brake.
- Low in Maintenance.



WHY GLASS YARNS ARE TWISTED ON RING TWISTER?

Our Ring Twister with the innovative and futuristic design has a broad range of functions for sensitive yarns like glass Fibers. Twisting Glass Yarns on MEERA Ring Twister offers premium quality yarn. Glass Twisted yarn with a perfect looking package is a prerequisite for further processing of the yarns when making fabrics. This is possible because of precisely controlled ring rail movement using a ball screw encoder system.

TAKE - UP PACKAGE SHAPES

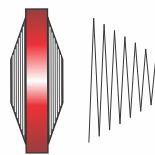

1

WRAP WINDING

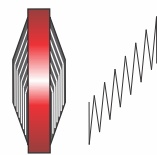

2

FILLING WINDING

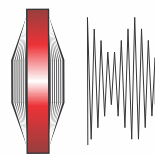

3

WANDERING WINDING

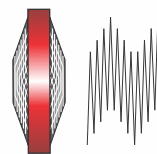

4

COMPOUND WINDING

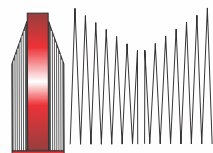

5

BOTTLE WINDING

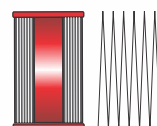

6

BOBBIN WINDING



HARD CHROMED DELIVERY ROLLERS

with double hard chromed delivery rollers and pressurised pressure roller that reduces yarn slippage to zero. Pneumatically piston to lift the pressure roller in case of feeding yarn breakage Delivery speed up to 120 m/min.

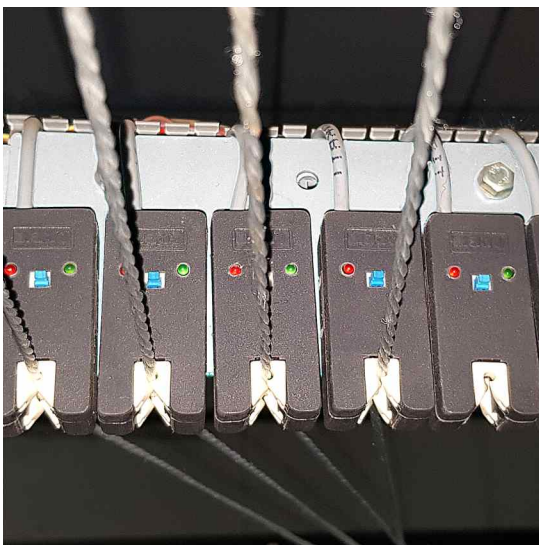

YARN BREAKAGE CONTROL

Event of yarn Breakage, Yarn Completion, are controlled by High Quality Sensors. These events are clearly indicated by a visible signal.

In case of Breakage, Ply Missing, Entanglement the ancillary functions, such as spindle stop and Pressure Roller auto lift are activated.





ANTI-BALLOON RING

Antiballoon Ring / Limiter Ring is given for running of heavy denier yarns at higher speed.



NO OF PLY

There is a Provision of Overhead Creel Up to 3 Ply. For More than 3 Ply a Front Creel can be provided with advance creel features.

- 250 - 300 MM Package Width.
- Rolling Spool for Unwinding of Twisted Yarns.
- Washer Tension Device for each Ply.
- Optical Sensor For Individual Ply.



BOBBIN OPTIONS

Range of Single / Double Flanged Bobbin to Choose.

- Flange 135 x Length 112
- Flange 150 x Length 165
- Flange 150 x Length 400
- Flange 180 x Length 450
- Flange 190 x Length 420
- Flange 180 x Length 400
- Flange 227 x Length 450
- Flange 227 x Length 550



RING SIZE AND HEIGHT OPTIONS

Depending upon denier and Yarn type there are various Ring Diameter options Available. 140 mm | 165mm | 200 mm | 250 mm | 300 mm

RING HEIGHT SELECTION

Ring Height	Denier
9.5 MM	160-2500
16.7 MM	500-12500
25.4 MM	1000-26600
38.1 MM	1500-60000

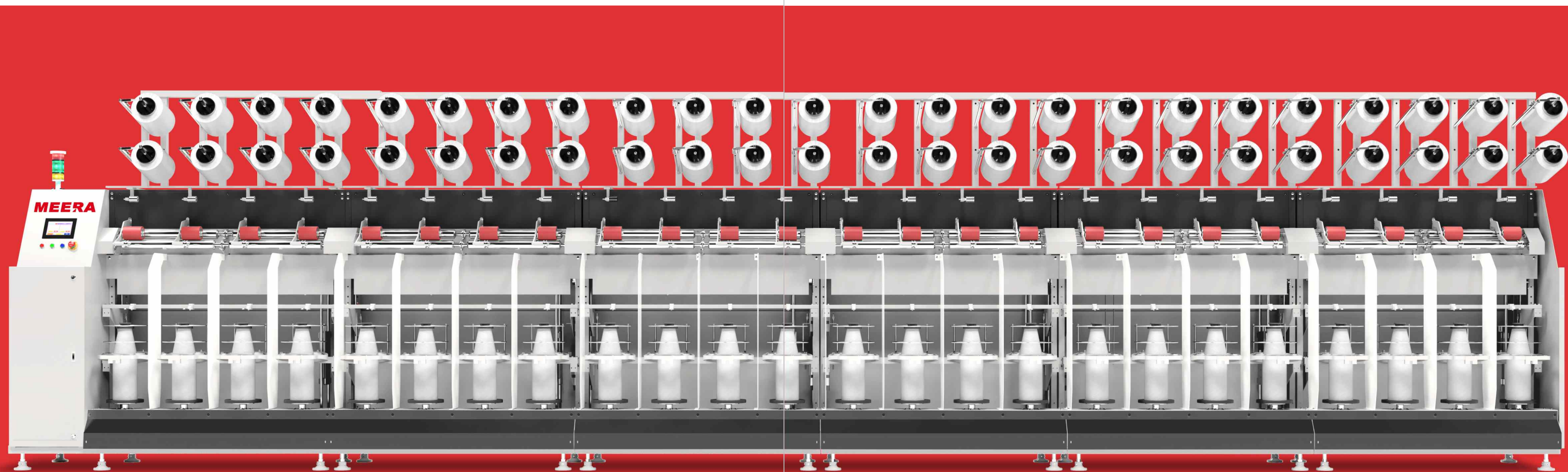

RING TWISTER APPLICATIONS



MULTI FILAMENT YARN	MONO FILAMENT / TAPE	ADVANCE MATERIAL	STAPLE FIBRES
Polyester (PES) Nylon (PA) Polypropylene (PP) Recycled Polyester (PET)	Polyethylene (PE) High Density (HDPE) UHMPE tape (UHMPE)	Glass Fiber Carbon Aramid Dyneema Copper Metallic Yarns	Cotton Viscose Wool Natural Fibers Silk Linen Blended Yarn,

APPLICATION

Packaging Yarns, Raffia, Artificial Grass, Ropes, Packaging Braids, Mops and Floor Sweepers, Carpets, Protection, Sports, Conveyor Belt, Safety Belts, Geo Textiles, Cords, Braider Yarns, Twines, Cordages, Sewing Thread For Big Bags, Yarns for Narrow Fabrics, Technical Yarns, Cover Yarns, passementerie, fishing, Fence Wire, Slings, hoses.

Ring Twister , Spindle Gauge 250, Model - R-140, R-160 (Frame : Single Deck Both Side)

No Position		12	24	36	48	60	72	84	96	108	120
Machine Length (L)	MM	3080	4940	6800	8660	10520	12380	14240	16100	17960	19820
	Ft	10.10	16.21	22.31	28.41	34.51	40.62	46.72	52.82	58.92	65.03

Ring Twister , Spindle Gauge 300, Model - R-200 (Frame : Single Deck Both Side)

No Position		10	20	30	40	50	60	70	80	90	100
Machine Length (L)	MM	5095	7032.5	8970	10907.5	12845	14782.5	16720	18657.5	20595	1220
	Ft	16.72	23.07	29.43	35.79	42.14	48.50	54.86	61.21	67.57	4.00

Ring Twister , Spindle Gauge 375, Model - R-250, R-300 (Frame : Single Deck Both Side)

No Position		8	16	24	32	40	48	56	64	72	80
Machine Length (L)	MM	2770	4320	5870	7420	8970	10520	12070	13620	15170	16720
	Ft	9.09	14.17	19.26	24.34	29.43	34.51	39.60	44.69	49.77	54.86

